

Introduction to

Concordia University

2024-2025

Major in Electroacoustic Studies



Specialization in
Electroacoustic Recording Arts

Specialization in
Electroacoustic Creative Practices

Minor in Electroacoustic Studies

COMMENTS . . .

In short, and longer

*Electroacoustic Studies programs focus on the hearing and creativity using **sound** as the music itself. The program does so through exploring multichannel (surround/immersive) composition, synthesis, collaborative live-performance, solo, small and large ensembles, while learning fundamental aspects sound technologies, acoustics, and detailed perception.*

Professor Eldad Tsabary

The EaSt program *opened my ears* not only to a world of new and exciting music, but also new ways of listening to, perceiving, and working with sound. Within this flexible learning environment, facilitated by encouraging and open-minded professors, I felt free to explore any creative sound-based ideas I might have.

NL 2020

"The EaSt program *changed the way I'm hearing sounds* around me. Now, I feel much more confident and cautious about how I deal with the art of sonic sculpting, thanks to the committed and inspiring teachers and a stimulating syllabus that was carefully laid out to challenge me one step at a time."

CC 2020

"The EaSt program has been an experience beyond what I ever expected. The key was keeping an open mind and letting all the new perspectives and possibilities of sound envelope my creative mind.
The program is demanding, but the opportunities have been endless. The key is staying present and informed with all the things that the department and the university have to offer.
The professors are more attentive and caring than any other university experience I have had. My classmates are especially supportive, and the program encourages that support and community."

AD 2020

"The Concordia Electroacoustic Studies Major provided me with the tools to build a strong foundation for my own research-creative practices. The EaSt program allowed me to branch out and explore many different interdisciplinary practices and research methods, . . ."

KP 2020

Prepare yourself to let go of everything you think you know . . . [and] trust in a decades-old process that fundamentally alters your perception. Be brave, be ambitious and let go of your sacred cows.

AS 2020

. . . I've so deeply enjoyed the studies.

I'm incredibly grateful to have been given the opportunity to be part of the program. My growth as an artist and musician has been exponential, but also my growth as a person, as an individual.

... to me, the most astonishing thing about the program is its balance between high academic standards and the well-being/development of each individual student. I've felt academically and personally supported in a very enriching, [comforting], and challenging way. It is rare to find teachers who will only ask from their students to truly deepen their understanding of themselves.

. . . With many fellow students in the program, we've shared how grateful we are to have had you as our teacher and advisor. You expect some sort of 'excellence' from your students but not one that you have already pre-defined in your mind - instead you try to understand who your student is and how they can excel in being "who they are".

. . . This is very unique and I'm proud to have had you as part of my growth. Thank you so much for all the feedback and the advising you've given me, the discussion we've shared, and sharing a little of who you are - all of this includes so much already.

Obviously, the program is full of incredibly inspiring and motivating students. That's a huge part of the program, if not the most important one.

PG 2021

1. Background, interests and expectations

2. What the programs are

3. Courses, content and objectives

4. Researching electroacoustics

5. Application Process

6. Preparing a strong portfolio

7. Facilities and Project Opportunities

8. Parents Ask . . .

9. Addenda and Examples to Compose

CONTACTS:

Mark Corwin [Professor, Coordinator]

mark.corwin@concordia.ca

Kevin Austin [Professor]

kevin.austin@concordia.ca

Ricardo Dal Farra [Professor]

ricardo.dalfarra@concordia.ca

Eldad Tsabary [Professor]

eldad.tsabary@concordia.ca

Please contact us for information, with questions, with examples of the work you do, what you are looking for in a university program.

Concordia University

Major / Minor and Specializations in Electroacoustic Studies



1. Background, interests and expectations

Greetings

Reading through these documents is designed to:

- > help you through the application process,
- >> describe the important parts of the programs, and
- >>> help you determine if this is the program you want to be in.

Applicants whose interests, expectations and backgrounds are similar to what the program can offer find themselves in a productive, open, receptive environment. The following pages are designed to help you understand a bit more about what electroacoustics “is” in the Concordia environment.

Several times as you read through, you will be invited to consider what you are looking for – your *interests* and *expectations*, and to express this in a number of ways during the application process.

The documents are:

- 1. **Background**, interests and expectations
- 2. **What** the program is, and What it isn't
- 3. **Courses**, content and objective
- 4. **Researching** electroacoustics and related words, and Contacting the area
- 5. **Application** process
- 6. **Portfolio** preparation
- 7. **Facilities** space and equipment
- 8. **Parents Ask . . .**
- 9. **Addenda** assistance in building a strong portfolio and application

[a] **What to include** in the Portfolio

[b] Types of **examples**



[Otto 8-channel studio]

Are you interested in all kinds of sounds?

>> Inventing sound-designed atmospheres

telling stories

transforming sounds

creating imaginary audio soundscapes

working in multichannel environments

performing with others

location recording

studio production

pushing your ears and hearing

exploring analog modular synthesis

creating sounds for dancers and animators

virtual synthesis and live coding

and more . . . you have found the place you want to be.

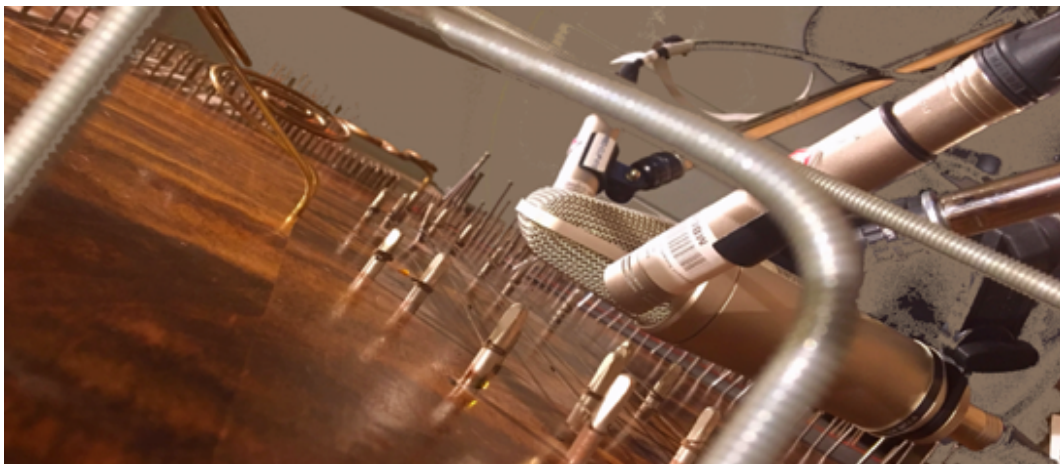

Sound Sculpture, Studio II

Images in the document are taken in the Electroacoustics Studios and from live performances.

Concordia University

Electroacoustic Studies Programs [4]

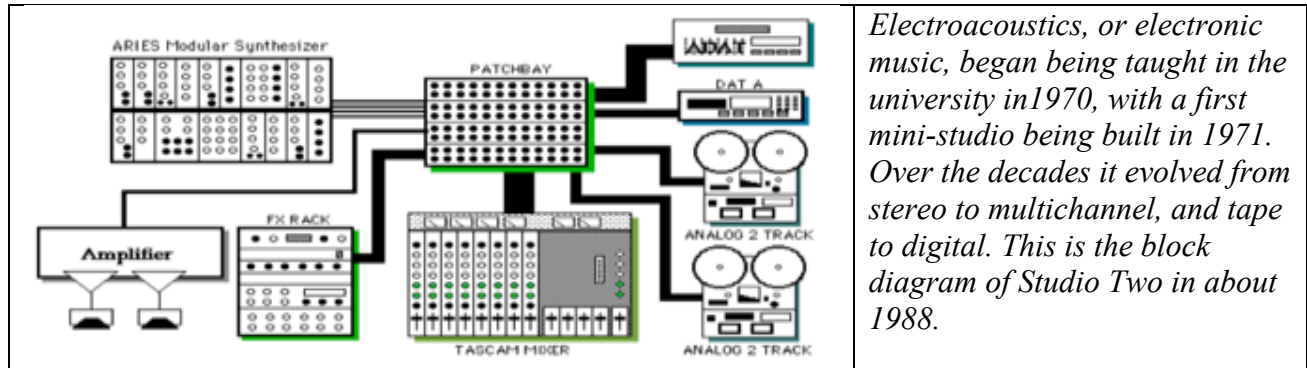

Electroacoustics, or electronic music, began being taught in the university in 1970, with a first mini-studio being built in 1971. Over the decades it evolved from stereo to multichannel, and tape to digital. This is the block diagram of Studio Two in about 1988.

2. What the programs are

There are four programs in *Electroacoustic Studies [EaSt]* at the undergraduate level. The Department of Music offers a

- Major in Electroacoustic Studies, 54 credits
- Minor in Electroacoustic Studies, 24 credits
- Specialization in Electroacoustic Creative Practices, 60 credits
- Specialization in Electroacoustic Recording Arts, 60 credits

History

In 2000, the Major and Minor in Electroacoustic Studies [EaSt] were formalized in the Concordia University Calendar. 'Sound courses' are taught in more than four departments at Concordia University, with **Electroacoustic Studies** being a program in the **Department of Music** in the **Faculty of Fine Arts**.

Since the 1970s, ea students have created and composed pieces and sound design elements for their own projects, animation, film and video, dance and theater, and recorded university ensembles, their own and others' bands, and themselves. They have gone on to successfully work in the industry and graduate studies.

What is the program able to offer

The **Electroacoustic Studies** programs are broad-based programs accepting students from a wide range of preparatory backgrounds. The general focus is on the refined development and expansion of the individual student's hearing, listening, sonic imagination skills, and abilities to hear and create sounds.

A strength of the program is being in Montreal, as an area in one of Canada's largest and most diversified Faculties of Fine Arts. This provides an immediate and continuous connection to artists from more than a dozen disciplines, including film, animation, theater, dance, gaming design, sound art, video, computer and digital design arts, performance art etc.



Every year more than half of the students in the program select to work with others in various departments or from outside the university on a wide range of creative projects from sound design to recording projects, mostly in inter- and cross-disciplinary contexts.

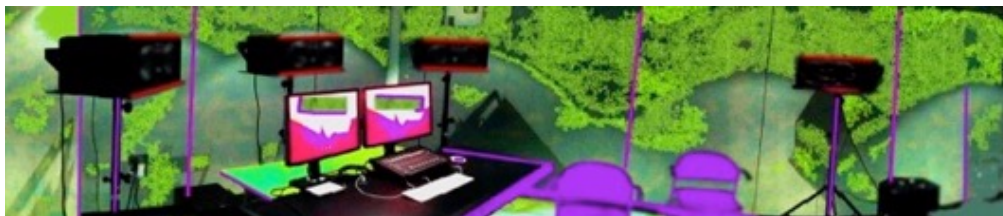

Who applies?

Applications come from around the world and all across Canada besides coming from Québec. Most of those accepted have worked individually, commercially or in school on a range of sound projects, learning and mastering the fundamentals of commercial software apps.

In general, first year students will have between 1 and 4 years of working with sound from many disciplines. As such, *neither* the Major *nor* the Minor in Electroacoustic Studies is an introductory sound program. These fundamental skills should be acquired before applying, for example by taking the course, EAST 203.

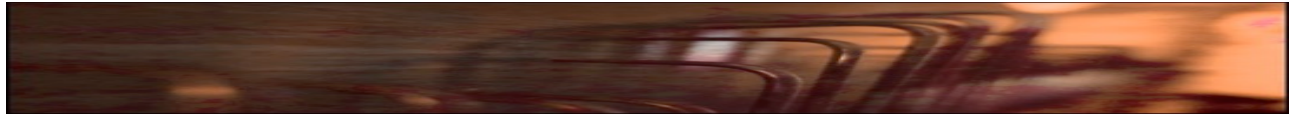

However, what does the program not focus on

As will become clear in the next section, the program is **not** an ordinary *commercial music technology / music production* program teaching about how technology can be used in traditional music environments. The program is also not a full university-level *recording arts program*, with the aim of training engineers and technicians to work in commercial recording studios. The **Specialization in Electroacoustic Recording Arts** does provide a wide and deep, solid basis for continued work in the field.

What are the options?

As of 2022, there were 50+ institutions / schools in Canada that have some form of music / recording courses. One for every interest and budget. There is the *YouTube* school of tutorials. There are a few undergraduate degrees which 'include' music production, but this isn't really a three or four-year university level education for simple music production. These programs tend to be built inside Music programs that include music theory, history some performance and music technology.

The 'real' education in studio work is found in some larger cities including Nashville, New York, Los Vega, Los Angeles and London, frequented by hundreds every year looking for internships. Recording, mixing and mastering depend on one thing: hearing. The EaSt program focuses on hearing and the development of technical skills in a creative environment.

The program embraces my vision of electroacoustic music and composition . . .
.electroacoustic composition . . .focuses on sculpting the sound as an object. [and] is intent on sculpting the time to develop a narrative.

The courses available in the program . . . support an art form that pushes the composer to develop their own idiosyncratic concepts of composition, beyond purely technical consideration

The program truly pushes every student to their maximum, in a very supportive way. I am surrounded by teachers and students that all have their personal experience with music and organizing sounds. Being able to have an insight inside their vision of what this vast field means to them is incredibly enriching and inspiring.

PG 2020

Concordia University

Major in Electroacoustic Studies



The Major in Electroacoustic Studies [EaSt] expresses a very clear educational and artistic creative philosophy through the design of all of the courses in the area.

3. Courses, content and objectives

The **Major in Electroacoustic Studies** is the core electroacoustics program offered by the Department.

Central to this program are closely integrated courses, given in a progressive and expanding framework of core courses including [apart from studio and recording courses]: two years of electroacoustic and traditional music **ear-training courses**, and one and a half years of **music theory and composition** [MIDIstration] **courses**.

The electroacoustic ear-training aspects of the courses are built on the development of a detailed and refined ‘psychophysical ear’, which is keenly attuned to *sound* as such – the sonic aspects which cannot be easily represented in traditional notational forms.

The development of these intensive **ear-training skills** finds a strong creative outlet in the up to 4 years of **ea studio-based courses**, including a quasi mini-thesis, *Capstone Project* of each students’ individual design. These courses are a combination of lecture components and research, and studio assignments.

Assignments are all compositional in nature, and cover basic and advanced skills in composition and analysis in areas such as detailed digital editing, many aspects of sound design and the creative, transformational use of processors and plugins, live ea composition and performance, modular analog synthesis, technical studies, soundscaping, and freely-designed projects.

These core aspects of aural development are complemented by up to four years of **recording courses**, starting with a foundational course introducing basic recording techniques and equipment, and a solid grounding in the basics of acoustics.

Each year of the program is strongly integrated between courses, and the courses themselves have a defined ascending year-over-year development in terms of skills, development, and creative applications of course objectives.



Of particular note is that the studios are all multi-channel, two five channel studios, and an eight-channel studio. The classroom is 9.5 [nine channels with 5 subwoofers]. From the first day, the studio assignments are in five-channels.



Other important courses offered in the program include **virtual modular synthesis** [MAX/MSP], the **laptop orchestra** [CLOrk], the **history and repertoire of electroacoustics**, **supervised internships**, **Capstone** courses, and **independent study**.

There is intensive focus on modular – virtual and eurorack – synthesis, live performance, cross-disciplinary opportunities, and supervised internships.

Concordia University

Electroacoustic Studies Programs [4]



It is important to understand what 'electroacoustic studies' is in the Concordia context. To start to understand this requires some research. The three main places to do this are: Wikipedia, YouTube, and contact with instructors in the program.

4. Researching electroacoustics

Is this the program for you?

Historically, about 110–120 people finished the application process each year. About one half are found to be acceptable applications. The others were either looking for the wrong program – a *focused recording arts* or *commercial music production / technology* etc program, or did not have enough background at this time.

Where to start the research?

A good place to start is with Wikipedia!

- Start with ***electroacoustics***, https://en.wikipedia.org/wiki/Acoustical_engineering#Electroacoustics which will lead to an acoustical engineering page.
- Try ***electroacoustic music*** https://en.wikipedia.org/wiki/Electroacoustic_music, which will lead to a more fruitful page.
- Find the names of links, including ***musique concrete*** https://en.wikipedia.org/wiki/Musique_concrète
- ***electronic music*** https://en.wikipedia.org/wiki/Electronic_music
- ***tape music*** and the names of some historical composers, *Pierre Schaeffer*, *Karlheinz Stockhausen* etc.
- Go to **YouTube**, put in these names and start listening to their work.

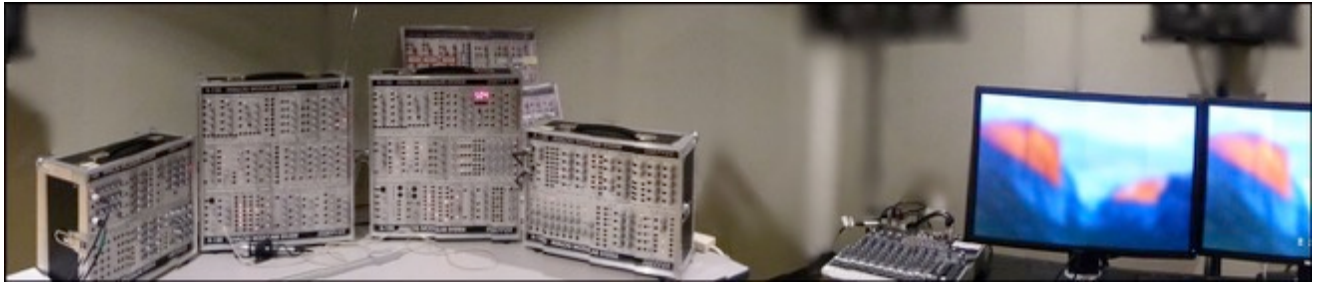

Marcelle Studio and Doepfer modular system, 2009-2023.

Closer to Home

Go to **YouTube**, and search **Concordia Electroacoustics**,

https://www.youtube.com/results?search_query=concordia+electroacoustics

where you will find several hundred examples of the multidisciplinary of the program.

Two other important resources are:

- **JTTP**, which is a national competition for sound artists / composers that has run for almost 25 years, <https://jttp.sonus.ca> and it is a good idea to listen to the top four or five winning pieces from a number of years, and
- • **sonus.ca** <http://www.sonus.ca>, is a web-based collection with a few thousand ea pieces representing a very wide range of styles and forms.

Do these sounds interest you and catch your attention? This could be the program for you!

Contact an instructor

Having done some research, you will want to contact an instructor in the program. The fulltime instructors are the admissions committee. You will be able to get strong, useful directed advice about the works for your *portfolio* by contacting the department *before* the submission deadline. Some people call as early as September.

Mark Corwin	mark.corwin@concordia.ca
Kevin Austin	kevin.austin@concordia.ca
Ricardo Dal Farra	ricardo.dalfarra@concordia.ca
Eldad Tsabary	eldad.tsabary@concordia.ca

For more detail about contacting someone, and getting feedback on your work, please continue reading down to *Section Six, Preparing a strong portfolio*.

Other useful information

Admission to the program has become highly competitive. The current admissions quota is about 35 per year. There are often more than 25 ‘accepted’ applicants who could not be admitted as there was no space in the program for them.

The electroacoustic studies classroom and studios on the eighth-floor of the John Molson School of Business on the corner of rue Guy and boulevard de Maisonneuve – metro Guy-Concordia, in downtown Montreal, Québec, Canada, are briefly described in Section 7.

Concordia University

Electroacoustic Studies Programs [4]

Major in Electroacoustic Studies [EaSt]
Minor in Electroacoustic Studies [EaSt]

Information
And
Letter of Intent

Acceptance into the Major or Minor in Electroacoustic Studies is based entirely on the documentation presented in the online Admissions Application form.

5. Application Process

Criteria

Acceptance to the Electroacoustic Studies programs is based entirely on the documentation presented in the online Application process. The documentation consists of two parts:

- **Electroacoustic Studies Admissions Application Form**
- **Portfolio**

The *Electroacoustic Studies Admissions Application Form* provides the Admissions Committee with a relatively complete picture of your background, your interests and your expectations with regards to the program. Please feel free to contact any of the instructors listed above at any time.

It is best to read through the Electroacoustic Studies Admissions Application Form before starting so that you know what is being asked for. The sections are as follows:

Basics: name, date of birth, address, email, Concordia ID, which program you are applying for, date of application etc

Education: general information on your education background

Expectations: briefly, what are you looking for in the program

Portfolio: *Please see below*

Sound background: general and specific information about your background in / with sound

Technical Information: your familiarity with software and hardware

Music background: your previous and current music background and activities

Other arts background: interests / activities in other arts

Professional / work background: if applicable

Other information: other things you would like the committee to know

Definitions: a list of terms to be defined in **20-60** words

Music Theory background: formal or informal music training.

Music theory quiz: a short quiz to determine your theory level This is not an admissions test, it is for placement only.

Letter of Intent: This may be completed in one of two forms, an itemized table, or a free-form open letter, whichever is more comfortable for you.



Portfolio:

The *Portfolio* is the **most important part** of your support documentation. This is where you will upload between 3 and 5 examples, up to about 3-4 minutes of your work. For each example, there is space to give the title, duration, program / production note, information on sources and processes, and your intention in creating the work, eg, for a video, for coursework, for the portfolio etc.

Faculty remain available throughout the year to assist in portfolio development. Please see **page 4** for **Contact** information.

Please see the following section for ***Preparing a Strong Portfolio***

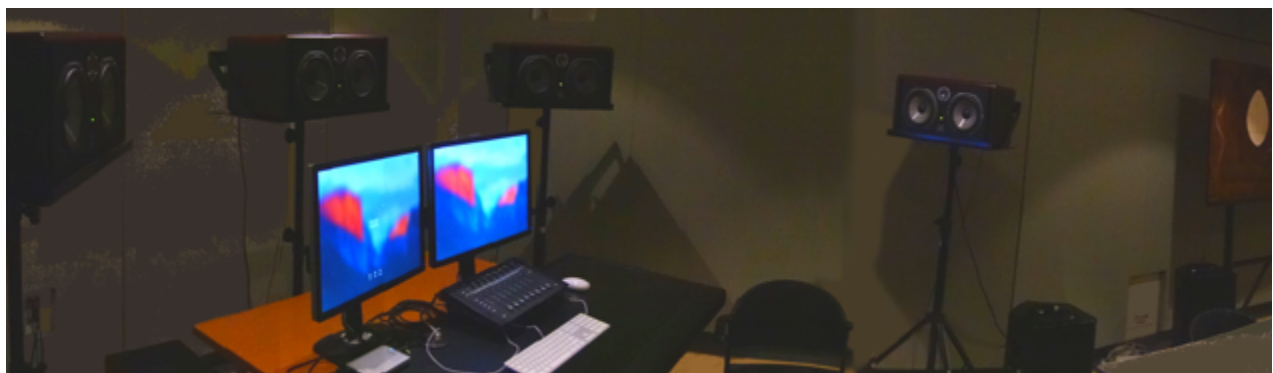

Concordia University

Electroacoustic Studies Programs [4]

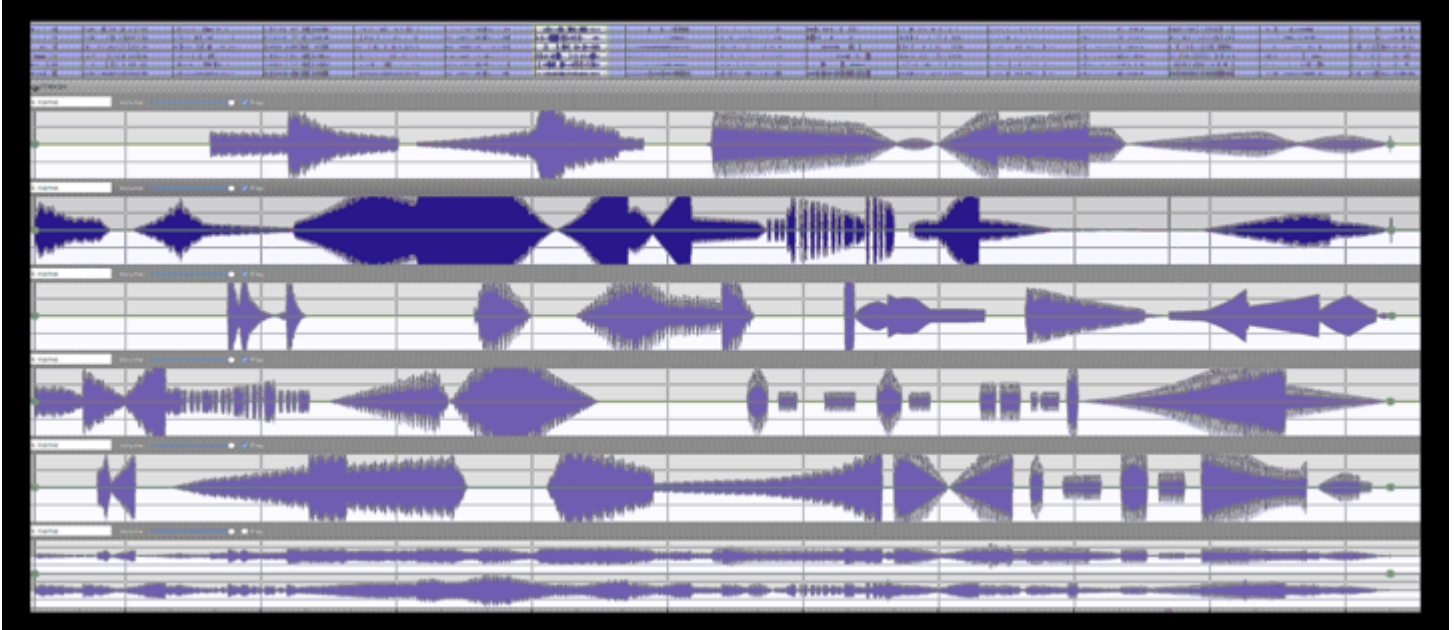

6. Preparing a strong portfolio

As noted, the portfolio submission is the most important part of the application process. See also, **Section 9** below for detailed information.

Select your best, most representative examples

The committee listens to the portfolio examples in great detail. The work needs to be technically correct, *normalized* and accurate. The examples need to demonstrate the depth of your work – the quality aspect. Is the work simply samples taken from low quality mp3 samples? Or is it carefully selected soundscape recordings? Is the processing standard DAW plugins used in standard, clichéd ways, or is there careful attention to all of the sounds, all the time?

- Are the examples all recordings of you and your band? Perhaps you are looking for a dedicated recording arts / music production program.
- Are they examples of you singing songs you've written? Perhaps the song-writing area of the Department of Music is what you are looking for.
- Are you really interested in the sociology and buzz around music and performers? Perhaps the Department of Communication Studies is what you want to look into.



The Hive Recording Studio

Are you interested in all kinds of sounds?

*>> Inventing sound-designed atmospheres,
telling stories,
transforming sounds,
creating imaginary audio soundscapes,
working in multichannel environments,
performing with others,
location recording,
pushing your ears and hearing,
exploring analog modular synthesis,
creating sounds for dancers and animators,
virtual synthesis and live coding,
and more . . . you have found the place you want to be.*



I learned a lot about raw sound manipulation and the possibilities of just using cut, copy, paste, reverse, and enveloping. The array of possible sounds from just a fraction of a second of sound truly astounded me and really opened my eyes as to what this program entails and what kind of work will be expected in the future. I enjoyed working on this . . . especially because it is the first time I've ever worked on something in 5 channels. It is truly a different experience when listening to the accurate and surreal spatialization of sound.

Concordia University

Electroacoustic Studies Programs



7. Facilities and Project Opportunities

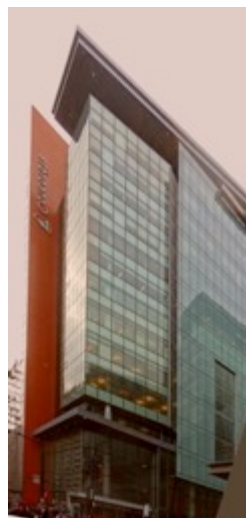

The s program facilities are housed on the 8th floor of the John Molson School of Business in downtown Montreal.

Built to very high acoustical standards, all of the classrooms, studios and practice rooms are acoustically treated and isolated.

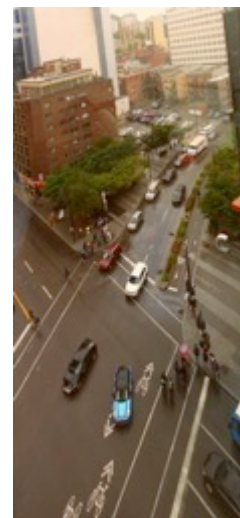

CLASSROOM

There is one classroom with a 9.5 surround sound system, 2024 Mac Studio computer, HD video projector, mixers, DVD audio player, ZOOM interface and cabling to the *Hive Recording Studio*.



The EaSt classroom is the center for all classes, and is used for visiting lecturers, research presentations, concerts and more. A notable feature of the classroom has been its use as a node for international performances with the **Laptop Orchestra** [*CLOrk*] and others around the world.

EA STUDIOS

There are three electroacoustic studies studios in the Department of Music, and others available through the Center for Digital Arts [CDA].



Marcelle Studio 2023

The *first-year studio*, “Marcelle”, named for the Montreal electroacoustics pioneer Marcelle Deschênes, is a 5.1 channel studio, with a 2024 Mac Studio computer. It has a 50+ module Doepfer Modular Analog Synthesizer, along with some eurorack modules.

The assignments for the first-year course are completed here. Assignments include a multichannel *piano soundboard* piece; a live / mixed ea assignment – prepared in this studio, and presented in the classroom; an in-depth introduction to analog modular parametric synthesis, and a soundscaping project



The **second-year studio** is a 5.1 channel studio with a 2024 Mac Studio computer. It has a 50+ module Doepfer Modular Analog Synthesizer, and about a dozen eurorack modules, O-Control, O-Coast, Strega, Maths, Beads etc.

There are also metal percussion, gongs and metal and wood sound sculpture object, the *Primordium*.

The course projects in second year are of a more extended nature. Some students also take the opportunity to create sound design tracks for the graduating animation students.

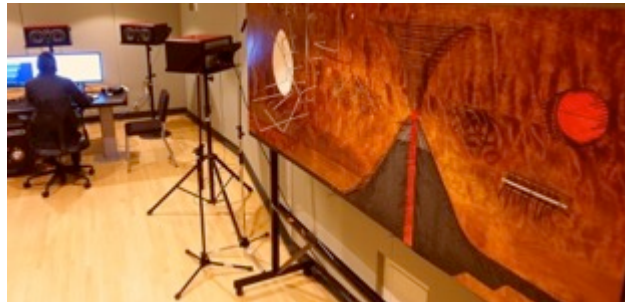

The Doepfer Modular Analog Synthesis system was a 96 module unit in use as a single instrument from 2009-2023. In 2023 the modular synthesis components for the studios expanded with the addition of about 20 eurorack compound modules, including Maths, Strega, O-Control, Spectraphon, Beads, XPO, SuperCell ...

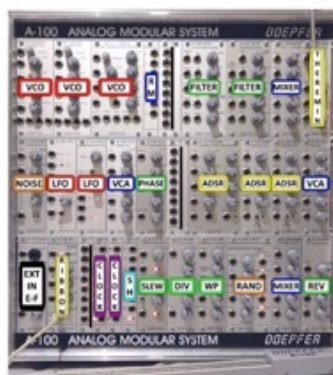
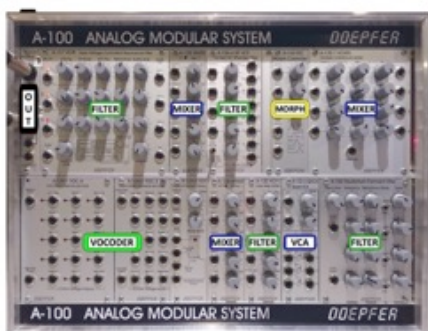

The Doepfer modules include a complement of 12 oscillators, filters, amplifiers, ADSRs, noise and random sources, a variety of logic-processing modules, a vocoder, three Theremins, 8-16 stage sequencer, spring reverb, and three ribbon controllers etc

Details available upon request.

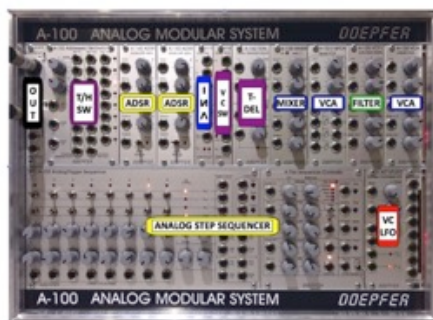

Doepfer system 2009 – 2023, eurorack winter 2024



Otto eight-channel studio

The **third-year studio**, “Otto”, named for the Canadian electronic music pioneer, **Otto Joachim**, is an 8.1 ‘double-diamond’ configuration, with a 2023 Mac studio computer. The focus in this studio is on larger projects, often final year, full-semester ‘Capstone’ pieces. Sound design tracks for animation students are also created in this studio which is mostly reserved for final year classes.

THE HIVE

The “Hive” is a small multi-track stereo recording project studio adjacent to a recording room that can record small ensembles. The studio is the focus of students in the second-year recording class and mixes small studio sessions, with larger – sometimes remote recording sessions.



The Hive 2021

The Hive employs a Pro Tools HD/Ultimate systems that use Avid HD i/o units with C24 control interfaces, with outboard equipment. There is a wide array of microphones in the studio, and more microphones are available from the ‘Depot’ on the same floor, operated by the Center for Digital Arts.





THE OSCAR PETERSON CONCERT HALL RECORDING STUDIO

The Oscar Peterson Concert Hall Recording Studio is a multi-track stereo recording studio attached to the Oscar Peterson Concert Hall on the Loyola Campus of Concordia University. The Oscar Peterson Concert Hall Recording Studio is equipped with a Pro Tools HD/Ultimate systems that use Avid HD i/o units with C24 control interfaces with outboard equipment. There is a wide array of microphones, stands and accessories, with more microphones available from the 'Depot', operated by the Center for Digital Arts.

The stage of the Oscar Peterson Concert Hall is the main recording venue. Solo, small ensemble, bands, singers, chamber groups, choirs and small orchestras are recorded from the stage.

THE DEPOT, SOFTWARE and HARDWARE

The CDA Depot has a wide range of audio equipment available to students for academic projects. Software is standardized across the classroom, ea studios, recording studios and about 10 studios operated by the CDA.



CDA provides the latest available versions. A sample of the software available includes:

Ableton Live , Altiverb,
Amadeus, Audacity, Avid
Aphex, Avid First AIR
Instruments Bundle, Avid
Protools, Avid Protools Ultimate
[HD], Avid Sibelius, Cecilia,
EAnalysis, Finale, Graphic
Converter, GRM tools, Intaglio,
Izotope Ozone & RX, Logic X,
Max MSP, Pd (PureData), Sonic
Visualizer, Sound Grain, Sound
Hack, Sound Toys

More than 60 microphones, stands, cables, amplifiers, portable audio recorders, video recorders, cameras etc provide an extensive complement of equipment for a wide range of student activities.

Including
AKG C414, D112 MKII, D5; Audio Technica ATM4050, AT875R; Audix D2, D4, D6, i5; CAD E200; Electro-Voice RE20; Neumann KM 183, KM 184, U87 A; Oktava MK-012, Rode NT2-A; Schertler Basik-Pro; Sennheiser EW100 G3, MD 441-U, MD421-II; Shure SM 57, SM 58, SM 81, SM 87, stereo and four-channel Zoom field recorders, sound cards, small and medium-size mixers, video cameras etc



PROJECT OPPORTUNITIES

Being within a Faculty of Fine Arts, there are many opportunities for collaborative and multi-disciplinary work., The EaSt area annually organizes extra opportunities through project production, the two largest being, from about 2010 until 2020 **60x60**, and since 2009, the **Animation, Sound and Music Project**.

60x60, on hold for 2023-24, is a one-hour live production of the Departments of Contemporary Dance, Theater and Music. Read about it and see a video here:

<http://www.concordia.ca/cunews/finearts/2017/05/video-watch-60-60-concordia-2017.html>



The **Animation, Sound and Music Project** was started in 2009 to provide professional quality soundtracks – sound design and music, for graduating animation students in the *Mel Oppenheim School of Cinema*. EaSt participants provide sound design and other sound elements for the animations, and often compose music scores for animators who wish to use original music. Being an interuniversity collaboration as well, the scores are recorded in the world-class recording studios at McGill University.

For example, in 2019, there are about 25 collaborations taking place involving more than 60 students. The on-going work is supervised by more than six faculty members. The soundtracks are composed in 5.1 especially for presentation at national and international festivals, and a two-channel version of the soundtrack is prepared for net distribution services.

A meeting for the **Animation, Sound and Music Project**.



There are numerous other opportunities to collaborate and network within the Faculty of Fine Arts and the broader Montreal creative fine arts communities including for example, sound design for theater productions, sound for installations and performance art, and working on Indie group productions.

During my Electroacoustic Studies degree, I learned to approach sound as a synergetic whole: Sound as an atmospheric pressure displacement, sound as an electrically transduced vibration (both by the brain, as impulses, and by microphones/loudspeakers, as a signal), and sound as the perception resulting from a sensory body's encounter with, and parsing of, its surrounding vibrations.

VS 2020

Concordia University

Electroacoustic Studies Programs



8. Parents Ask . . .

Due to the wide range of backgrounds in sound / electroacoustics, there are few things which are common to all applicants – a passion for sound.

Some in the program discovered their attachment to sound in their early teens and have been working in the medium for 5, 10 or 20+ years. Some discover the power of sound while studying in other disciplines, often music, but frequently film studies / production, communication studies, gender studies, computer sciences, business studies; effectively from all areas.

The first year classes are filled with students just out of high school from across Canada and the USA, just out of Cégep for Québec students, many over 21 in the Mature Entry program, and for some, this is their second or third university degree. Every year there are a few over the age of 28 who have been working in the industry for a while and want to extend their range of skills and knowledge.

With an admissions quota of about 35 and annual applications in the 120+ range, acceptance is quite competitive. As noted above, the Electroacoustic Studies area encourages all who are interested in the program to contact the area to have assistance in preparing the portfolio.



And parents often ask, . . . “What are the employment opportunities in this field?”

A ***Burning Glass Report***, a national survey of hundreds of companies in the audio field, was commissioned by Concordia University’s Office of the Provost in the spring of 2019. The first statement in the Report reads:

There is [a] clear trend towards an increase in jobs per year that require the skills that [are] offered through these [ea] programs, suggesting growth in this area
(Report 1: Job Counts by Year)

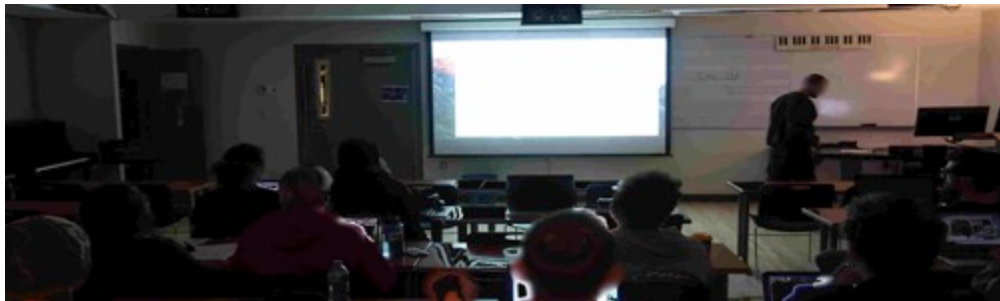

University is an educational opportunity, not a trade school. That said, the Electroacoustic Studies program serves many real-world areas. The basic development of the applicant’s aural acuity and skills prepares them to work in a very wide range of fields – anywhere a loudspeaker is found is fertile ground for employment opportunities.

In line with Concordia’s broader societal responsibilities and objectives, those in the programs are encouraged to work within the broader local and regional communities, and there are upper level courses offering opportunities for supervised internships.

This all translates into working across the arts and communications areas of: recording – commercial or independent, sound related to film and media – location recording to sound design and composition; research – graduate level or in industries as broad as noise assessment to improving the lives of hearing impaired people; sound-art–based therapies; speech and sound recognition applications [AI]; independent production / recording studios; independent artist – living as independent artist, an activity widely supported by independent and governmental arts councils.

To simplify, loudspeakers are everywhere in society, from phones to cars, computers and classrooms. This flexible program works to improve the ear, and its objectives can be turned to any field that uses loudspeaker.



Being undergraduate degrees, the program provides some general focus on three areas:

- the Major is a strong broad-based foundational program
- the Specialization in Creative Practices places upper level emphasis on the creation / invention of sounds, sound design, composition and performance
- the Specialization in Recording Arts places upper level emphasis on the development of a broadly-based recording portfolio, live and studio, solo and group, pop – commercial – concert, independently, or in the industry

All three programs prepare the graduate to continue into graduate studies, move into the industry, or, as often happens, do both at the same time.

The Electroacoustic Studies program also encourages the growth of a community of like-minded individuals. Over the couple of decades of the program, this international network now numbers somewhere around a thousand graduates and former students.

As is well-known, the university can't assure success, but there is the commitment to providing the broadest, most focused educational opportunities available in a liberal arts Fine Arts faculty.

Concordia University

Electroacoustic Studies Programs



9. Addenda

[a] What to include in the Portfolio

The evaluation of the portfolio is the most important part of the admissions process.

Does the portfolio reflect your interest in what the program is about, and is able to offer?

The portfolio needs to reflect this breadth and depth of interest. Breadth means a wide range of interest and examples. Depth means solid basic technical skills. These may require research, including Wikipedia and YouTube tutorials.

- Each example presented needs to come with a description, or two. The committee is interested in your ability to describe your objectives, both in a generalized and specialized way. Aim to communicate directly, not simply 4 words, and not 150 words. These 'program notes' will inform the committee of the breadth of your research on the subject. Do you have a good vocabulary? Can you say what you mean in 15 words or less?
- Briefly document your production techniques. Provide enough information about the context of the work. Is this something you do all the time, or is it prepared for the portfolio. What did you learn while preparing the example?
- You may wish to include a spectrogram.

[b] Types of examples

- Short pieces – often assignments from previous classes
- Soundscape
- Sound design for video, dance, gaming, theater etc
- Short pieces created for the portfolio

[c] Some basic approaches to preparation

Files should be worked on at 24/96kHz, or 24/48kHz. If possible, do *not* use *mp3* as source materials. Understand the concepts of sample rate and bit depth, and normalization. System limitations require submission as *mp3s* however. If there is a video, in the notes explain your roles in its production.

The *compositional process* will can place basically in two stages: [i] preparation of materials, selection, editing transformation, and [ii] composition / format, mixing, mastering.

Given here is a basic way to develop a simple but comprehensive work method for the first stage. The steps will overlap, but in general the workflow would be:

- consider what you want to do
- generate / collect source materials
 - select and edit
 - sort, organize, process and transform
 - repeat
- organize the stems [clips] into folders

- create a session
- start assembly
- compositional considerations
- producing tracks for mixing / spatialization

- **[1] Consider what you want to do:**
exploration transforming materials in software and plugins;
creation of a real or imaginary soundscape;
a piece that sets a mood or tells a story;
sound design for a project
etc

- **[2] Consider possibilities for sound sources:**
virtual synths
hardware synths
recorded acoustical sources, sound objects and soundscapes
effects from the web

The materials need to be of the highest possible quality, 24/96kHz wherever possible. Collect widely. Put all of the source materials into a couple of folders. Begin to select the 'most promising' sections. Be ready to throw away 70% of what you have collected. Edit the files into 'clips', name them, and put them into appropriate folders. These folders will each be a 'family' of sounds.

Begin collecting examples, 5 seconds to 20 seconds long, but not more than 3 or 4 minutes. Even this will be far too much once you get started. If your source material is more than about 20-30 seconds long, I suggest breaking it down into smaller files. The longer the files, the longer — and generally harder, the selection and editing process is.

- **[3] Select and edit.**

Make sure they are *all* rich, distinctive sources. You don't want to start with weak core materials. Explore extreme high and low registers. You will always be able to combine them later into more complex individual sonorities.

- **[4] Sort, process and transform; organize, document.**

The basic transformations and processing are fundamental to the creation of high quality fundamental materials. Remain flexible with the materials. Avoid adding reverb at this stage, unless reverb is integral to the sound. It is easier to later add reverb than to try to remove it.

This process is where the *families of sounds* will begin to develop. One simple source could be processed in many more than 10 different ways. This can produce an organically-related set of materials, simplifying the compositional process later.

Explore transformations

Explore transformations across all parameters, speed change, pitch shifting, modulations, amplitude change, filtering, and extreme forms of signal transformation, extreme high and low frequencies, extreme amplification / clipping – also sometimes called distortion.

Explore, listen, edit, select, sort. Repeat.

The next step is to go to each of the 'family' folders, sort and critically edit your materials. Take one file at a time, and start to process it. Experiment widely. You will likely find that 15 seconds of source material generates a couple of minutes of materials, which themselves will need to be sorted and edited. Store these clips in a sub folder of the 'family'.

Create subfolders as necessary, for you will need to be able to find your files. You may want to start a small spreadsheet or **Word** Table which will contain the file name, its duration and a very brief description. This documentation may come in very handy if you need to reproduce a particular kind of transformation.

This sorting and processing — especially the processing, needs to be detailed and very wide. High quality needs to be maintained at every step. Consider whether signals are mostly ‘frequencies’ or ‘noises’, static or active. Are the spectra high, and low? Are there many different amplitudes and envelopes?

***Amplification** can be extreme — adding 20 dB, for a short period of time in a small part of the wave can produce startling results, changing the character of the sound.*

Each of these effects can be repeated a number of times to make the transformations more extended. As you are doing this, I would recommend saving versions frequently to build up families of sounds.

After you have done about 5-8 families, you will come to the conclusion that you have 10 minutes of raw clips for a 1 1/2-minute piece. You probably won’t use *all* of the clips, but they will allow you to create a wide range of densities and dimensions. Sounds will be able to come in and go out over a space of three or four seconds. Sounds can play against each other while more sustained ‘pad-like’ or looped sounds, provide a canvas behind the front layers of activity,

Make sure they are all rich, distinctive sources. You don’t want to start with weak core materials. Explore extreme high and low registers. You will always be able to combine them into more complex individual sonorities.

The following demonstrates a couple of methods of transforming sounds using simple, basic techniques including copy and paste, changing amplitude [re-enveloping], pitch change, and time stretching. A way of changing the spectrum is to use a 1/3 octave equalizer, and another way was to add reverb, multiple times — each time starting later in the signal.

The use of multiple channels allows for easy production of background and foreground sounds. Panning can be done locally, on each sound, or globally on semi-mixed sounds.

Start with some of the shorter ones. Begin exploring basic transformations, register, density, spectrum, gesture. Do not use automation or MIDI controllers. Use your ears all the time to take decisions. Keep the quality high [normalize throughout], and keep a small collection of 5 - 10 of the best in a folder called [for example] **Family 1 [short]**.

Take another clip, and repeat the process. The order of processing will likely change as you will have become more familiar with the kinds of things that will happen. Do unusual things — things you have not done before. Try extreme speed change, extreme editing, extreme eq. Explore, collect, and move on, having created the folder **Family 2**.

- **[5] Repeat. Explore differently.**

Explore some two-channel techniques like channel-exchange, and slicing clips into a lot of smaller clips, and reversing the channels on every other clip — a form of manual channel-switching.

- **[6] Repeat.**

You have created a *repertoire* of materials to use in your composition.

- **[7] Create a session.**

Put in 16 empty mono tracks. Decide on an approximate length, say 90-100 seconds, and set the end-of-file to 2 minutes. You now have the sonic canvas, empty, but defining a number of starting points, and the materials to 'paint' your sonic canvas.

- **[8] Assembling the project**

Begin dropping elements from the repertoire of families into the session. As you will have a pretty good idea of your materials, you will have developed some ideas as to where and how things could go. Put them in, play around. Don't start at the beginning, but just put in interesting things in different places.

Keep listening, but you don't need to take many decisions at this time. Keep listening. Move the files about. Adjust their amplitudes. Adjust the start and stop points. Have them work together; have them respond to each other.

Slowly the canvas / session fills up. The piece begins to take shape. If you need more materials, new materials of transformations, make them. Add them to your repertoire of materials.

- **[9] The final composition**

Suddenly [!] you will find that you are ready to do a rough mix. Do a rough mix. Listen to it in loop mode for about 10 minutes. Note what is good, note what is weak. Go back into the session and work to create 'highlights' of the really good things.

At some point, the piece will need to be finished. Do a 'Master Mix'. Listen to it a few times, and put it away for a few days. Go back a few days later, and check it out. Is it ready? Put it in the portfolio or make the few minor repairs, and then package it.

Set as a goal a "one-minute Study" that will explore one particular kind of idea. Maybe the idea of 'exchange', or "high and low", light and heavy, fast and slow, near and far, static and dynamic, 100 high frequency sounds, all about very low beats, sounds that start and stop unpredictably, 8 channels of beats at different speeds . . . etc etc.

As the assembly continues, you may find it necessary to reprocess the clips [stems], lengthen, shorten, filter, drop or raise in frequency etc. Always be sure that it is not the software that is making the creative decisions. Spend a couple of days on a study. Work on other studies. Put the study away for a week or so, and then go back to it with fresh ears.

When you work on a mix, use extreme placement and panning as well as the standard approach to use of 'stereo'. Explore. Keep your listener interested and engaged.

[d] Editing / composing at the wave level

Editing and composing at the wave level is a good way for the ear to come in direct contact with the fundamental aspects of a sound. Instead of working with a repeating sample, such as a beat pattern:

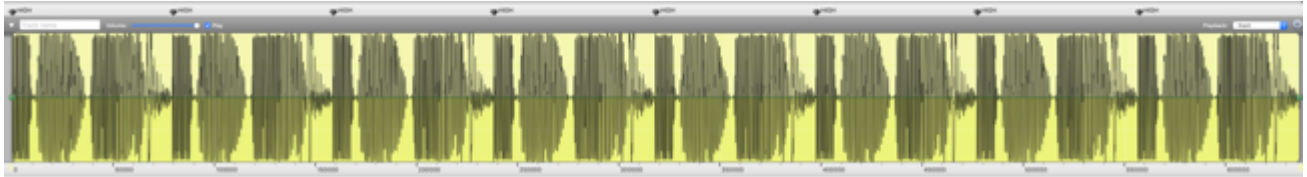

grab a small part of the signal:

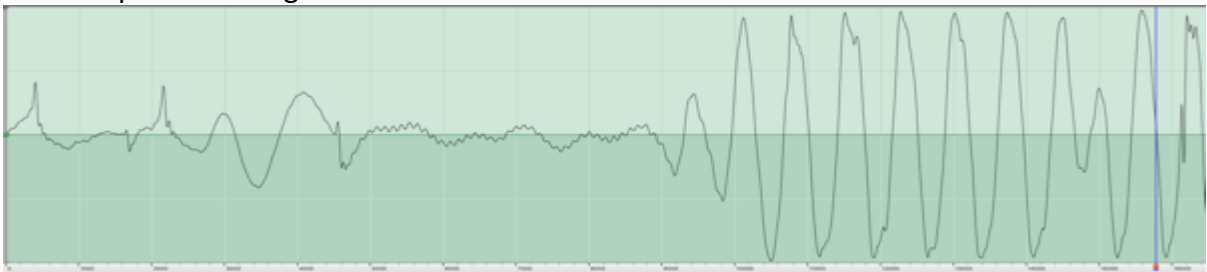

This is about 1/3 of a second – 330ms. Take about 2500 samples, copy and paste it repeatedly. A new sound emerges. Because it is a wave repeating at audio rate, it has a clearly identifiable frequency [pitch].

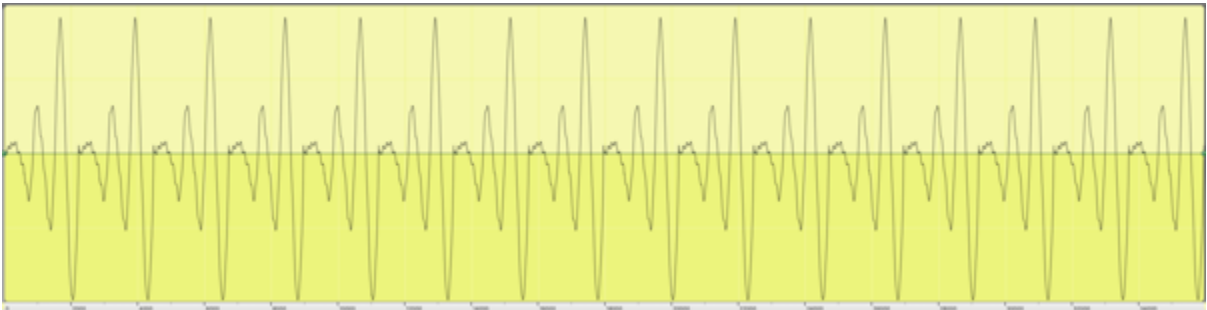

Give it an amplitude envelope:

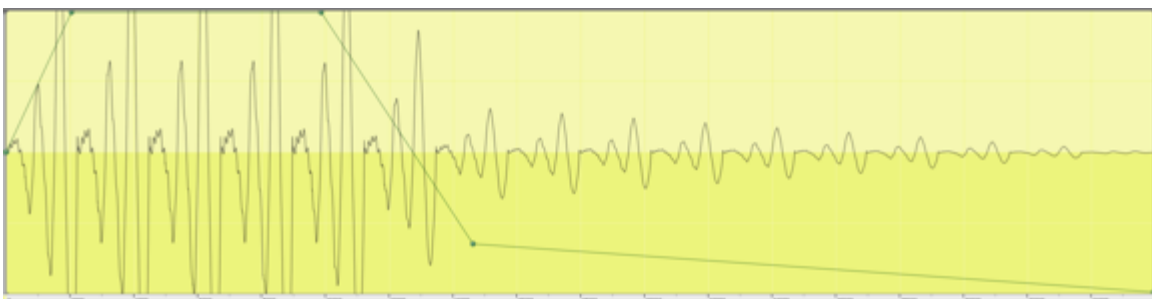

Copy it, with simple processing:

- Add three empty tracks.
 - Paste the copy into track 2. Reverse it.
- Copy it. Paste a copy into track 3. Slow it down by 60%.
- Copy it. Paste a copy into track 4. Reverse it; pitch shift up an octave, stretch it to 140%.

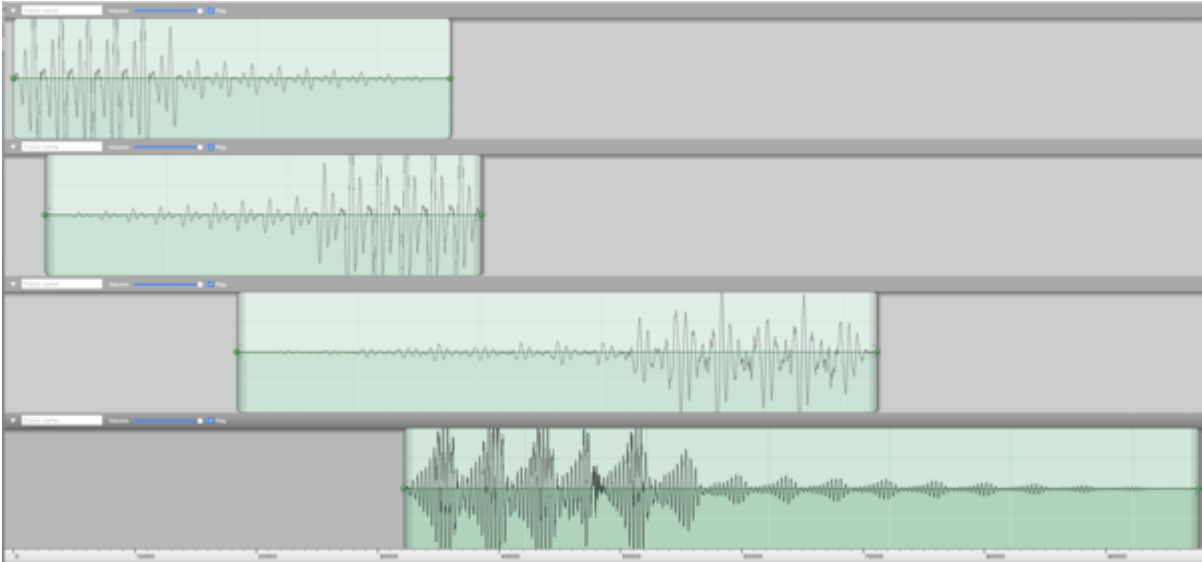

Explore.

Merge [mix] the tracks together, and modify the envelope.

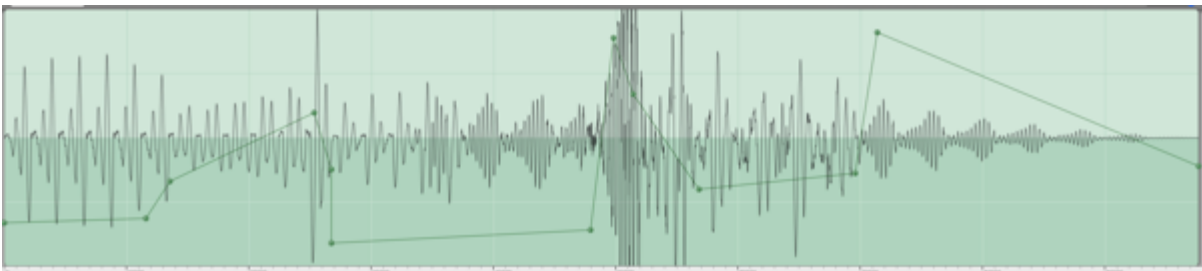

New sounds, new sonic gestures.

[e] Explore common sounds, such as the voice

Editing and composing at the wave level is a good way for the ear to come in direct contact with the microelements of sounds. Here is the word 'Stately'.

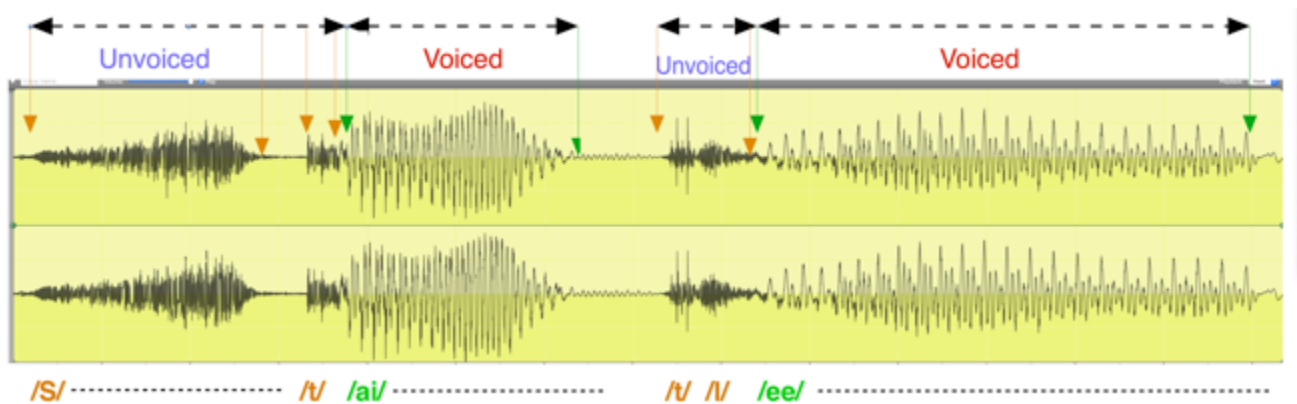

It is made up of six elements / phonemes:

/s/ /t/ /ai/ /t/ /l/ /ee/

underneath the waveshape.

There are two kinds of sounds: voiced – /ai/ /ee/,
and unvoiced – /s/ /t/ /l/
indicated above the waveshape.

Unvoiced sounds are complex and noise-like; voiced sounds have a more regular / recurring waveshape.

Record a few words – including your name! Edit the voiced and unvoiced sounds. Duplicate them and create an unusual 'vocal' piece with the resulting materials. Change the amplitude, duration, frequency etc. Use the techniques explained in [c] and [d] above to create a short study for the portfolio.

Concordia University

Electroacoustic Studies Programs



9. Addenda

The **evaluation of the portfolio** is the most important part of the admissions process. Does the portfolio reflect your interest in what the program is about, and is able to offer? The portfolio needs to reflect this breadth and depth of interest. Breadth means a wide range of interest and examples. Depth means solid basic technical skills. These may require research, including Wikipedia and YouTube tutorials.

- Each example presented needs to come with a description, or two. The committee is interested in your ability to describe your objectives. Aim to communicate directly, not simply 4 words, and not 150 words.
- Briefly document your production techniques.

The EaSt Program . . . dramatically changed the way I listen to sounds as a whole. . . . a deep and profound learning experience towards understanding sound that is around us, and [provides] whole new skill sets for transforming audio . . .

AP 2020

SOME TYPES of EXAMPLES

- Short pieces – often assignments from previous classes
- Soundscape
- Sound design for video, dance, gaming, theater etc
- Short pieces created for the portfolio

Unvoiced consonants and Soundscape, for applicants

Below are two short studies that can be prepared for the portfolio for the application to the Electroacoustic Studies programs.



Unvoiced consonants This is a short study in audio editing / composition. The final will be a two-channel piece. The duration is to be 30-60 seconds.

Briefly, the study is done in two stages, but they may overlap. A detailed description follows.

- The pre-compositional stage is the collection and processing of the source materials. These 'stems' are your basic repertoire.
 - In the compositional stage, these stems are put into a DAW session, and then a finished mix is produced.
 - The source material is drawn from a short mono recording of yourself [24 bit 48kHz]. The sounds are limited to unvoiced consonants, /s/, /t/, /ch/ etc. Research the term if you are not sure about it.
 - Process these unvoiced consonants only with:
 - cut, copy, paste
 - change amplitude [*]
- [* includes manual envelopes, normalization, compression and peak limiting, fade in / fade out]
- The work is done in an audio editor, at the wave level.

Experiment.

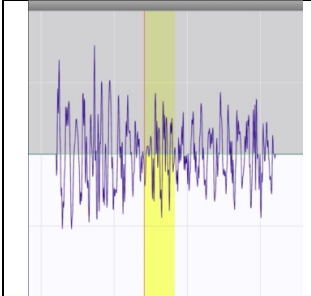
Cut out little bits of the signal, 20 to 500-1000 samples. Join these stems together [randomly?], and create envelopes for them. They will be quite short. Copy a part of the wave, and paste in back into the wave, repeatedly, 5 to 10 times. This will create various kinds of oscillating signal.

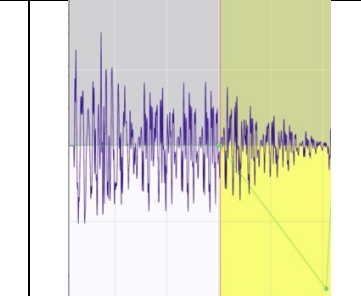
		
Start with a stem. Copy a small section of it.	Paste this many times into the original signal. Listen and experiment with different sizes, and mixing different stems.	Re-envelope the stem.

Save examples of what you do: short / long, high frequency / middle frequency, etc

Try to create different ‘families’ of sounds. When you save them, save them with a creative name so you can look through the folder and find the different sounds.

The Composition Phase: The session and Monitoring

When you have a good collection of these sounds, you will create the ‘canvas’ [like a painter], that you will build the piece in.

CANVAS	
L	<input type="text"/>
LC	<input type="text"/>
C	<input type="text"/>
RC	<input type="text"/>
R	<input type="text"/>
L	<input type="text"/>
LC	<input type="text"/>
C	<input type="text"/>
RC	<input type="text"/>
R	<input type="text"/>
<i>etc</i> L	<input type="text"/>
LC	<input type="text"/>
C	<input type="text"/>
RC	<input type="text"/>
R	<input type="text"/>

In your DAW, create a session 30-60 seconds induration.

Create 10, [or 15 or more!] mono audio tracks.

This is where the composition will take place.

Each track is associated with a ‘position’ in the stereo field.

Since space and direction are important features, the ‘direction’ of the signal will be determined by the panning on each track. The tracks will be in groups of five with their panning being:

- Left, • Left Center, • Center, • Right Center, • Right. These correspond to the five speaker positions in the studio.

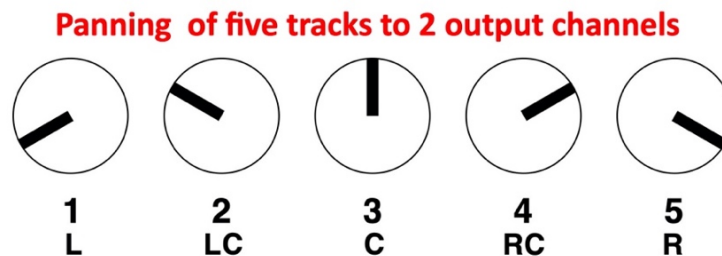

Monitoring with headphones is most effective, but not necessary.

Compositional process:

Copy stems from your 'repertoire' folder and place them in the session. Experiment. Move them about. Put lots together in one region, place similar ones in different locations to create dialog and conversation.

It is not necessary to start at the beginning.

When you find you have a decent set of sounds, begin to modify their amplitudes. Increase / decrease levels, add envelopes. Create longer gestures. Create surprises. Have fun.

During this exploration, if you have any questions, please email me at:

kevin.austin@videotron.ca

Write a few notes on your experience.

+++++

Soundscape Study

A short study in sounds around and processing.

In this 1 – 2 minutes study, the source materials are whatever you happen to record in the environment, outside, in the city, in the country, a river, traffic, sounds inside a building etc. The selection of materials is wide open. With a portable recorder or phone, record some materials. I suggest that you not record more than 5-10 minutes as more than this can make selection and editing a much longer process. 24/48kHz, always.

Record sounds. Edit out interesting ones, long/short, near/far, stationary/moving etc.

Begin processing them with your favorite [and unknown] plugins.

Process, edit, and re-process. Do this several times if you feel strong!

Using the compositional technique described above – create a canvas, place stems into canvas, create a sketch, a soundscape, real or imaginary, a picture or a story.

Write a few notes on your experience.

Kevin Austin	<i>2024 –II – 13</i>
Electroacoustic Studies	Concordia University
Department of Music, Fine Arts	Montreal, Canada